

KEIL

MINI GUIDE





We are Drillcut.
Plumbing and HVAC
solutions that sit above
the ceiling and back of wall,
always thinking of new ways
to get the job done better.



METAL DRILL BITS	3
STEP DRILLS	15
WOOD DRILL BITS	15
SPADE BITS	16
SDS PLUS DRILL BITS	17
SDS MAX DRILL BITS	23
SDS CORE DRILLS	25
SYSTEM 259 OVERVIEW	27
SDS DUST EXTRACTION DRILLBITS	28
SDS ADAPTORS	28
SDS PLUS CHISELS	29
SDS MAX CHISELS	30
MASONRY DRILL BITS	31
UNIVERSAL & SPECIAL DRILL BITS	32
DIAMOND DRILL BITS	35

METAL DRILL BITS

KEIL HSS SPLIT POINT DRILL BIT



QUICK	PART NO	SIZE (MM)	WORKING LENGTH (MM)	LENGTH (MM)	PACK QTY
-	4-060443	1	12	34	10
-	4-060444	1.5	18	40	10
-	4-060445	2	24	49	10
-	4-060446	2.5	30	57	10
-	4-060447	3	33	61	10
-	4-060448	3.5	39	70	10
-	4-060449	4	43	75	10
-	4-060450	4.5	47	80	10
-	4-060451	5	52	86	10
-	4-060452	5.5	57	93	10
-	4-060453	6	57	93	10
-	4-060454	6.5	63	101	10
-	4-060455	7	69	109	10
-	4-060456	7.5	69	109	10
-	4-060457	8	75	117	10
-	4-060458	8.5	75	117	10
-	4-060459	9	81	125	10
-	4-060460	9.5	81	125	10
-	4-060461	10	87	133	10
-	4-060462	10.5	87	133	5
-	4-060463	11	94	142	5
-	4-060464	11.5	94	142	5
-	4-060465	12	101	151	5
-	4-060466	12.5	101	151	5
-	4-060467	13	101	151	5

KEIL HSS SPLIT POINT DRILL BIT - HANG PACK



QUICK	PART NO	SIZE (MM)	WORKING LENGTH (MM)	LENGTH (MM)	QTY / HANG PACK	CARTON QTY
-	4-060468	1	12	34	2	5
-	4-060469	1.5	18	40	2	5
-	4-060470	2	24	49	2	5
-	4-060471	2.5	30	57	2	5
-	4-060472	3	33	61	2	5
-	4-060473	3.5	39	70	2	5
-	4-060474	4	43	75	1	10
-	4-060475	4.5	47	80	1	10
-	4-060476	5	52	86	1	10
-	4-060477	5.5	57	93	1	10
-	4-060478	6	57	93	1	10
-	4-060479	6.5	63	101	1	10
-	4-060480	7	69	109	1	10
-	4-060481	7.5	69	109	1	10
-	4-060482	8	75	117	1	10
-	4-060483	8.5	75	117	1	10
-	4-060484	9	81	125	1	10
-	4-060485	9.5	81	125	1	10
-	4-060486	10	87	133	1	10
-	4-060487	10.5	87	133	1	5
-	4-060488	11	94	142	1	5
-	4-060489	11.5	94	142	1	5
-	4-060490	12	101	151	1	5
-	4-060491	12.5	101	151	1	5
-	4-060492	13	101	151	1	5

KEIL HSS SPLIT POINT LONG SERIES DRILL BIT



QUICK	PART NO	SIZE (MM)	WORKING LENGTH (MM)	LENGTH (MM)	PACK QTY
-	4-060493	2	56	85	10
-	4-060494	2.5	62	95	10
-	4-060495	3	66	100	10
-	4-060496	3.5	73	112	10
-	4-060497	4	78	119	10
-	4-060498	4.5	82	126	10
-	4-060499	5	87	132	10
-	4-060500	5.5	91	139	10
-	4-060501	6	91	139	10
-	4-060502	6.5	97	148	10
-	4-060503	7	102	156	10
-	4-060504	7.5	102	156	10
-	4-060505	8	109	165	10
-	4-060506	8.5	109	165	10
-	4-060507	9	115	175	10
-	4-060508	9.5	115	175	10
-	4-060509	10	121	184	10
-	4-060510	10.5	121	184	10
-	4-060511	11	128	195	10
-	4-060512	11.5	128	195	10
-	4-060513	12	134	205	10

KEIL HSS EXTRA LONG SERIES DRILL BIT



QUICK	PART NO	SIZE (MM)	WORKING LENGTH (MM)	LENGTH (MM)	PACK QTY
-	4-060514	3	130	190	1
-	4-060515	3.5	145	210	1
-	4-060516	4	190	280	1
-	4-060517	4.5	160	235	1
-	4-060518	5	170	245	1
-	4-060519	5.5	180	260	1
-	4-060520	6	225	330	1
-	4-060521	6.5	235	350	1
-	4-060522	7	250	370	1
-	4-060523	7.5	155	225	1
-	4-060524	8	265	390	1
-	4-060525	8.5	265	390	1
-	4-060526	9	280	410	1
-	4-060527	10	295	430	1

KEIL BLACK HSS DRILL BIT



QUICK	CODE	SIZE (MM)	WORKING LENGTH (MM)	LENGTH (MM)	PACK QTY
-	4-060528	1	12	34	10
-	4-060529	1.5	18	40	10
-	4-060530	2	24	49	10
-	4-060531	2.5	30	57	10
-	4-060532	3	33	61	10
-	4-060533	3.5	39	70	10
-	4-060534	4	43	75	10
-	4-060535	4.5	47	80	10
-	4-060536	5	52	86	10
-	4-060537	5.5	57	93	10
-	4-060538	6	57	93	10
-	4-060539	6.5	63	101	10
-	4-060540	7	69	109	10
-	4-060541	7.5	69	109	10
-	4-060542	8	75	117	10
-	4-060543	8.5	75	117	10
-	4-060544	9	81	125	10
-	4-060545	9.5	81	125	10
-	4-060546	10	87	133	10
-	4-060547	10.5	87	133	5
-	4-060548	11	94	142	5
-	4-060549	11.5	94	142	5
-	4-060550	12	101	151	5
-	4-060551	12.5	101	151	5
-	4-060552	13	101	151	5

KEIL BLACK HSS DRILL BIT - HANG PACK



QUICK	PART NO	SIZE (MM)	WORKING LENGTH (MM)	LENGTH (MM)	QTY / HANG PACK	CARTON QTY
-	4-060553	1	12	34	2	5
-	4-060554	1.5	18	40	2	5
-	4-060555	2	24	49	2	5
-	4-060556	2.5	30	57	2	5
-	4-060557	3	33	61	2	5
-	4-060558	3.5	39	70	2	5
-	4-060559	4	43	75	1	10
-	4-060560	4.5	47	80	1	10
-	4-060561	5	52	86	1	10
-	4-060562	5.5	57	93	1	10
-	4-060563	6	57	93	1	10
-	4-060564	6.5	63	101	1	10
-	4-060565	7	69	109	1	10
-	4-060566	7.5	69	109	1	10
-	4-060567	8	75	117	1	10
-	4-060568	8.5	75	117	1	10
-	4-060569	9	81	125	1	10
-	4-060570	9.5	81	125	1	10
-	4-060571	10	87	133	1	10
-	4-060572	10.5	87	133	5	5
-	4-060573	11	94	142	5	5
-	4-060574	11.5	94	142	5	5
-	4-060575	12	101	151	5	5
-	4-060576	12.5	101	151	5	5
-	4-060577	13	101	151	5	5

KEIL TIN HSS DRILL BIT



QUICK	CODE	SIZE (MM)	WORKING LENGTH (MM)	LENGTH (MM)	PACK QTY
-	4-060578	1	12	34	10
-	4-060579	1.5	18	40	10
-	4-060580	2	24	49	10
-	4-060581	2.5	30	57	10
-	4-060582	3	33	61	10
-	4-060583	3.5	39	70	10
-	4-060584	4	43	75	10
-	4-060585	4.5	47	80	10
-	4-060586	5	52	86	10
-	4-060587	5.5	57	93	10
-	4-060588	6	57	93	10
-	4-060589	6.5	63	101	10
-	4-060590	7	69	109	10
-	4-060591	7.5	69	109	10
-	4-060592	8	75	117	10
-	4-060593	8.5	75	117	10
-	4-060594	9	81	125	10
-	4-060595	9.5	81	125	10
-	4-060596	10	87	133	10
-	4-060597	10.5	87	133	10
-	4-060598	11	94	142	5
-	4-060599	11.5	94	142	5
-	4-060600	12	101	151	5
-	4-060601	12.5	101	151	5
-	4-060602	13	101	151	5

KEIL COBALT DRILL BIT



QUICK	PART NO	SIZE (MM)	WORKING LENGTH (MM)	LENGTH (MM)	PACK QTY
-	4-060620	1	12	34	10
-	4-060621	1.5	18	40	10
-	4-060622	2	24	49	10
-	4-060623	2.5	30	57	10
-	4-060624	3	33	61	10
-	4-060625	3.5	39	70	10
-	4-060626	4	43	75	10
-	4-060627	4.5	47	80	10
-	4-060628	5	52	86	10
-	4-060629	5.5	57	93	10
-	4-060630	6	57	93	10
-	4-060631	6.5	63	101	10
-	4-060632	7	69	109	10
-	4-060633	7.5	69	109	10
-	4-060634	8	75	117	10
-	4-060635	8.5	75	117	10
-	4-060636	9	81	125	10
-	4-060637	9.5	81	125	10
-	4-060638	10	87	133	10
-	4-060639	10.5	87	133	5
-	4-060640	11	94	142	5
-	4-060641	11.5	94	142	5
-	4-060642	12	101	151	5
-	4-060643	12.5	101	151	5
-	4-060644	13	101	151	5

KEIL COBALT DRILL BIT - HANG PACK



QUICK	CODE	SIZE (MM)	WORKING LENGTH (MM)	LENGTH (MM)	QTY / HANG PACK	CARTON QTY
-	4-060645	1	12	34	2/ Hang Pack	5
-	4-060646	1.5	18	40	2/ Hang Pack	5
-	4-060647	2	24	49	2/ Hang Pack	5
-	4-060648	2.5	30	57	2/ Hang Pack	5
-	4-060649	3	33	61	2/ Hang Pack	5
-	4-060650	3.5	39	70	2/ Hang Pack	5
-	4-060651	4	43	75	1/ Hang Pack	10
-	4-060652	4.5	47	80	1/ Hang Pack	10
-	4-060653	5	52	86	1/ Hang Pack	10
-	4-060654	5.5	57	93	1/ Hang Pack	10
-	4-060655	6	57	93	1/ Hang Pack	10
-	4-060656	6.5	63	101	1/ Hang Pack	10
-	4-060657	7	69	109	1/ Hang Pack	10
-	4-060658	7.5	69	109	1/ Hang Pack	10
-	4-060659	8	75	117	1/ Hang Pack	10
-	4-060660	8.5	75	117	1/ Hang Pack	10
-	4-060661	9	81	125	1/ Hang Pack	10
-	4-060662	9.5	81	125	1/ Hang Pack	10
-	4-060663	10	87	133	1/ Hang Pack	10
-	4-060664	10.5	87	133	1/ Hang Pack	5
-	4-060665	11	94	142	1/ Hang Pack	5
-	4-060666	11.5	94	142	1/ Hang Pack	5
-	4-060667	12	101	151	1/ Hang Pack	5
-	4-060668	12.5	101	151	1/ Hang Pack	5
-	4-060669	13	101	151	1/ Hang Pack	5

KEIL SPEEDER METAL DRILL BIT



QUICK	CODE	SIZE (MM)	WORKING LENGTH (MM)	LENGTH (MM)	PACK QTY
-	4-060670	3	33	61	1
-	4-060671	3.5	39	70	1
-	4-060672	4	43	75	1
-	4-060673	4.5	47	80	1
-	4-060674	5	52	86	1
-	4-060675	5.5	57	93	1
-	4-060676	6	57	93	1
-	4-060677	6.5	63	101	1
-	4-060678	7	69	109	1
-	4-060679	7.5	69	109	1
-	4-060680	8	75	117	1
-	4-060681	8.5	75	117	1
-	4-060682	9	81	125	1
-	4-060683	9.5	81	125	1
-	4-060684	10	87	133	1
-	4-060685	10.5	87	133	1
-	4-060686	11	94	142	1
-	4-060687	11.5	94	142	1
-	4-060688	12	101	151	1
-	4-060689	12.5	101	151	1
-	4-060690	13	101	151	1

KEIL DOUBLE END HSS DRILL BIT



QUICK	CODE	SIZE (MM)	WORKING LENGTH (MM)	LENGTH (MM)	PACK QTY
-	4-060607	#30 (1/8)	10	49	10
-	4-060605	#20 (5/32)	13	55	10
-	4-060603	#11 (3/16)	16	62	10

KEIL REDUCED SHANK HSS DRILL BIT



QUICK	CODE	SIZE (MM)	WORKING LENGTH (MM)	LENGTH (MM)	PACK QTY
-	4-060609	10.5	87	133	5
-	4-060610	11	94	142	5
-	4-060611	11.5	94	142	5
-	4-060612	12	101	151	5
-	4-060613	12.5	101	151	5
-	4-060614	13	101	151	5
-	4-060615	14	108	160	5
-	4-060616	15	114	169	5
-	4-060617	16	120	178	5
-	4-060618	18	130	191	5
-	4-060619	20	140	205	5

KEIL SINGLE END HSS DRILL BIT



QUICK	CODE	SIZE (MM)	WORKING LENGTH (MM)	LENGTH (MM)	PACK QTY
-	4-060608	#30 (1/8)	36	65	10
-	4-060606	#20 (5/32)	43	75	10
-	4-060604	#11 (3/16)	52	86	10

KEIL METRIC HSS DRILL SET - METAL BOX



QUICK	PART NO	NO OF PCS	PACK QTY
-	4-060695	19 - 1-10mm in 0.5mm increments	1
-	4-060696	25 - 1-13mm in 0.5mm increments	1

KEIL METRIC HSS DRILL SET - PLASTIC BOX

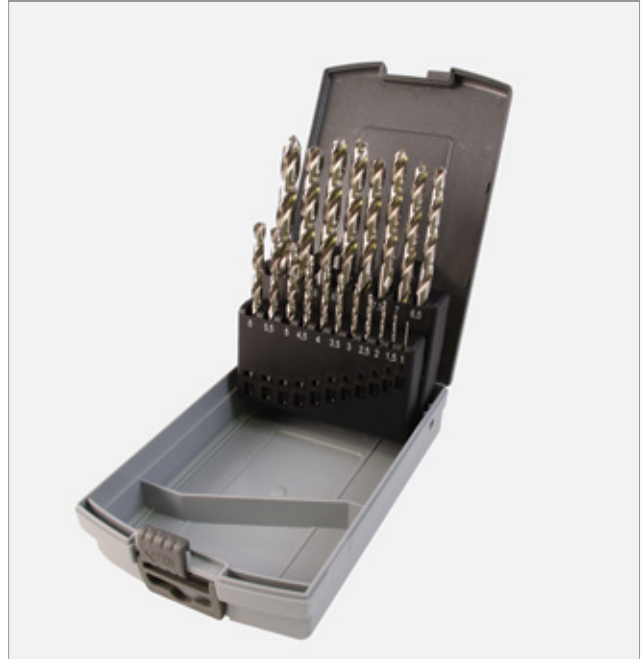

QUICK	PART NO	NO OF PCS	PACK QTY
-	4-060697	19 - 1-10mm in 0.5mm increments	1
-	4-060698	25 - 1-13mm in 0.5mm increments	1

KEIL METRIC BLACK HSS DRILL SET - METAL BOX



QUICK	PART NO	NO OF PCS	PACK QTY
-	4-060699	19 - 1-10mm in 0.5mm increments	1
-	4-060700	25 - 1-13mm in 0.5mm increments	1

KEIL METRIC BLACK HSS DRILL SET - PLASTIC BOX



QUICK	PART NO	NO OF PCS	PACK QTY
-	4-060701	19 - 1-10mm in 0.5mm increments	1
-	4-060702	25 - 1-13mm in 0.5mm increments	1

KEIL METRIC TIN HSS DRILL SET - PLASTIC BOX



QUICK	PART NO	NO OF PCS	PACK QTY
-	4-060703	19 - 1-10mm in 0.5mm increments	1
-	4-060704	25 - 1-13mm in 0.5mm increments	1

KEIL METRIC COBALT DRILL SET - METAL BOX

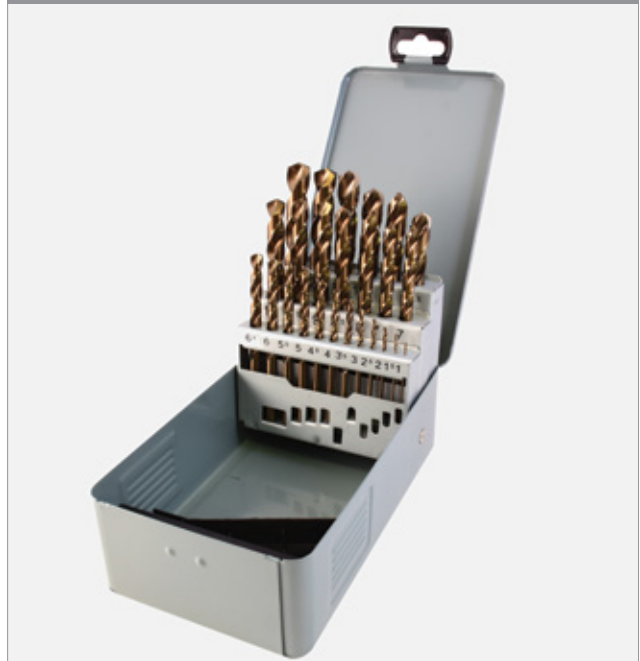

QUICK	PART NO	NO OF PCS	PACK QTY
-	4-060691	19 - 1-10mm in 0.5mm increments	1
-	4-060692	25 - 1-13mm in 0.5mm increments	1

KEIL METRIC COBALT DRILL SET - PLASTIC BOX



QUICK	PART NO	NO OF PCS	PACK QTY
-	4-060693	19 - 1-10mm in 0.5mm increments	1
-	4-060694	25 - 1-13mm in 0.5mm increments	1

STEP DRILLS

KEIL TUBE & SHEET DRILL



QUICK	PART NO	SIZE (MM)	PACK QTY
-	4-060705	3-14	1
-	4-060706	4-20	1
-	4-060711	4-31	1
-	4-060707	16-30.5	1
-	4-060708	24-40	1
-	4-060709	36-50	1
-	4-060710	40-61	1

KEIL HSS STEP DRILL



QUICK	PART NO	SIZE (MM)	PACK QTY
-	4-060712	4-12	1
-	4-060713	4-20	1
-	4-060714	6-30	1
-	4-060715	9-36	1
-	4-060716	7-32.5	1

WOOD DRILL BITS

KEIL HSS WOOD DRILL BIT



QUICK	PART NO	SIZE (MM)	WORKING LENGTH (MM)	LENGTH (MM)	PACK QTY	CARTON QTY
-	4-060739	4	43	75	1	20
-	4-060740	5	52	86	1	20
-	4-060741	6	57	93	1	20
-	4-060742	7	69	109	1	20
-	4-060743	8	75	117	1	20
-	4-060744	10	87	133	1	20
-	4-060745	12	96	151	1	10

KEIL TURBOWOOD TCT WOOD DRILL BIT



QUICK	PART NO	SIZE (MM)	WORKING LENGTH (MM)	LENGTH (MM)	PACK QTY	CARTON QTY
-	4-060717	4	40	75	1	20
-	4-060718	5	40	86	1	20
-	4-060719	6	45	93	1	20
-	4-060720	8	63	117	1	20
-	4-060721	10	61	120	1	20
-	4-060722	12	100	151	1	10

KEIL WOOD DRILL BIT



QUICK	PART NO	SIZE (MM)	WORKING LENGTH (MM)	LENGTH (MM)	PACK QTY	CARTON QTY
-	4-060723	3	33	61	1	20
-	4-060724	4	43	75	1	20
-	4-060725	5	52	86	1	20
-	4-060726	6	57	93	1	20
-	4-060727	7	69	109	1	20
-	4-060728	8	75	117	1	20
-	4-060729	9	80	120	1	20
-	4-060730	10	87	120	1	20
-	4-060731	11	89	142	1	10
-	4-060732	12	96	151	1	10
-	4-060733	13	96	151	1	10
-	4-060734	14	96	151	1	10
-	4-060735	15	100	160	1	10
-	4-060736	16	100	160	1	10
-	4-060737	18	130	180	1	5
-	4-060738	20	140	200	1	5

SPADE BITS

KEIL SPADE BIT - HANG PACK



QUICK	PART NO	SIZE (MM)	PACK QTY
-	4-060748	6	1
-	4-060749	8	1
-	4-060750	10	1
-	4-060751	12	1
-	4-060752	13	1
-	4-060753	14	1
-	4-060754	16	1
-	4-060755	18	1
-	4-060756	20	1
-	4-060757	22	1
-	4-060758	24	1
-	4-060759	25	1
-	4-060760	28	1
-	4-060761	30	1
-	4-060762	32	1
-	4-060763	35	1
-	4-060764	38	1
-	4-060765	40	1

KEIL 300MM SPADE BIT EXTENSION



QUICK	PART NO	LENGTH (MM)	PACK QTY
-	4-060746	300	1

SDS PLUS DRILL BITS

KEIL MS5 TURBOKEIL SDS PLUS DRILL BIT



QUICK	PART NO	SIZE (MM)	WORKING LENGTH (MM)	LENGTH (MM)	PACK QTY
-	4-060001	4	50	110	10
-	4-060002	4	100	160	10
-	4-060003	5	50	110	10
-	4-060004	5	100	160	10
-	4-060005	5	150	210	10
-	4-060006	5	200	260	10
-	4-060007	5	260	310	1
-	4-060008	5	350	410	1
-	4-060009	5.5	50	110	10
-	4-060010	5.5	100	160	10
-	4-060011	5.5	200	260	10
-	4-060012	6	50	110	10
-	4-060013	6	100	160	10
-	4-060014	6	150	210	10
-	4-060015	6	200	260	10
-	4-060016	6	300	360	1
-	4-060017	6	400	460	1
-	4-060018	6.5	50	110	10
-	4-060019	6.5	100	160	10
-	4-060020	6.5	150	210	10
-	4-060021	6.5	200	260	10
-	4-060022	7	50	110	10
-	4-060023	7	100	160	10
-	4-060024	8	50	110	10
-	4-060025	8	100	160	1
-	4-060026	8	150	210	1
-	4-060027	8	200	260	1
-	4-060028	8	250	310	1
-	4-060029	8	400	460	1
-	4-060030	8	550	600	1
-	4-060031	10	100	160	1
-	4-060032	10	150	210	1
-	4-060033	10	200	260	1
-	4-060034	10	400	460	1

QUICK	PART NO	SIZE (MM)	WORKING LENGTH (MM)	LENGTH (MM)	PACK QTY
-	4-060035	10	550	600	1
-	4-060036	10	950	1000	1
-	4-060037	12	100	160	1
-	4-060038	12	150	210	1
-	4-060039	12	200	250	1
-	4-060040	12	400	450	1
-	4-060041	12	550	600	1
-	4-060042	12	950	1000	1
-	4-060043	13	100	160	1
-	4-060044	13	200	260	1
-	4-060045	14	100	160	1
-	4-060046	14	150	210	1
-	4-060047	14	200	260	1
-	4-060048	14	250	310	1
-	4-060049	14	400	450	1
-	4-060050	14	550	600	1
-	4-060051	14	950	1000	1
-	4-060052	15	100	160	1
-	4-060053	15	200	260	1
-	4-060054	15	400	450	1
-	4-060055	16	100	160	1
-	4-060056	16	150	210	1
-	4-060057	16	200	250	1
-	4-060058	16	400	450	1
-	4-060059	16	550	600	1
-	4-060060	16	750	800	1
-	4-060061	16	950	1000	1
-	4-060062	18	150	200	1
-	4-060063	18	250	300	1
-	4-060064	18	400	450	1
-	4-060065	18	550	600	1
-	4-060066	18	950	1000	1
-	4-060067	20	150	200	1
-	4-060068	20	250	300	1
-	4-060069	20	400	450	1
-	4-060070	20	550	600	1
-	4-060071	20	950	1000	1
-	4-060072	22	200	250	1
-	4-060073	22	400	450	1
-	4-060074	22	550	600	1
-	4-060075	22	950	1000	1
-	4-060076	24	200	250	1
-	4-060077	24	400	450	1
-	4-060078	25	200	250	1
-	4-060079	25	400	450	1
-	4-060080	25	950	1000	1
-	4-060081	26	200	250	1
-	4-060082	26	400	450	1

KEIL MS5 TURBOKEIL SDS PLUS DRILL BIT BULK 10 PACK



QUICK	PART NO	SIZE (MM)	WORKING LENGTH (MM)	LENGTH (MM)
-	4-060083	5	50	110
-	4-060084	5	100	160
-	4-060085	6	50	110
-	4-060086	6	100	160
-	4-060087	6	150	210
-	4-060088	8	100	160
-	4-060089	8	150	210
-	4-060090	8	200	260
-	4-060091	10	100	160
-	4-060092	10	150	210
-	4-060093	10	200	260
-	4-060094	12	100	160
-	4-060095	12	150	210
-	4-060096	12	200	250
-	4-060097	14	200	250

KEIL MS5 TURBOKEIL SDS PLUS MULTIPACK 7/PK



QUICK	PART NO	PACK QTY
-	4-060098	10

KEIL KEILRAPID SDS PLUS DRILL BIT



QUICK	PART NO	SIZE (MM)	WORKING LENGTH (MM)	LENGTH (MM)	PACK QTY
-	4-060099	4	50	110	10
-	4-060100	4	100	160	10
-	4-060101	5	50	110	10
-	4-060102	5	100	160	10
-	4-060103	5.5	50	110	10
-	4-060104	5.5	100	160	10
-	4-060105	6	50	110	10
-	4-060106	6	100	160	10
-	4-060107	6	150	210	10
-	4-060108	6	200	260	10
-	4-060109	6.5	100	160	10
-	4-060110	6.5	150	210	10
-	4-060111	7	200	260	10
-	4-060112	8	50	110	10
-	4-060113	8	100	160	10
-	4-060114	8	150	210	10
-	4-060115	8	200	260	10
-	4-060116	10	100	160	10
-	4-060117	10	150	210	10
-	4-060118	10	200	260	10
-	4-060119	12	100	160	10
-	4-060120	12	150	210	10
-	4-060121	12	200	250	10
-	4-060122	12	400	450	1
-	4-060123	14	100	160	10
-	4-060124	14	150	210	10
-	4-060125	14	200	260	10
-	4-060126	14	250	310	1
-	4-060127	14	400	450	1
-	4-060128	16	100	160	10
-	4-060129	16	150	210	10
-	4-060130	16	250	300	1
-	4-060131	16	400	450	1
-	4-060132	18	200	260	1
-	4-060133	18	250	300	1
-	4-060134	18	400	450	1
-	4-060135	20	250	300	1
-	4-060136	20	400	450	1
-	4-060137	22	400	450	1
-	4-060138	25	400	450	1

KEIL MS5 TURBOHEAD XPRO SDS PLUS DRILL BIT



QUICK	PART NO	SIZE (MM)	WORKING LENGTH (MM)	LENGTH (MM)	PACK QTY
-	4-060139	5	50	110	10
-	4-060140	5	100	160	10
-	4-060141	5	150	210	10
-	4-060142	5	200	260	10
-	4-060143	5.5	50	110	10
-	4-060144	5.5	100	160	10
-	4-060145	5.5	150	210	10
-	4-060146	5.5	200	260	10
-	4-060147	6	50	110	10
-	4-060148	6	100	160	10
-	4-060149	6	150	210	10
-	4-060150	6	200	260	10
-	4-060151	6.5	100	160	10
-	4-060152	6.5	150	210	10
-	4-060153	6.5	200	260	10
-	4-060154	6.5	250	310	1
-	4-060155	8	50	110	10
-	4-060156	8	100	160	10
-	4-060157	8	150	210	10
-	4-060158	8	200	260	10
-	4-060159	10	100	160	10
-	4-060160	10	150	210	10
-	4-060161	10	200	260	10
-	4-060162	10	250	310	1
-	4-060163	10	300	360	1
-	4-060164	10	400	460	1
-	4-060165	10	550	600	1
-	4-060166	12	100	160	10
-	4-060167	12	150	210	10
-	4-060168	12	200	260	10
-	4-060169	12	250	310	1
-	4-060170	12	400	450	1
-	4-060171	12	550	600	1
-	4-060172	14	100	160	10
-	4-060173	14	150	210	10
-	4-060174	14	200	260	10
-	4-060175	14	250	310	1
-	4-060176	14	400	450	1
-	4-060177	14	550	600	1
-	4-060178	16	100	160	1
-	4-060179	16	200	260	5
-	4-060180	16	400	450	1
-	4-060181	16	550	600	1
-	4-060182	18	200	250	5
-	4-060183	18	400	450	1
-	4-060184	20	200	250	5
-	4-060185	20	400	450	1
-	4-060186	20	550	600	1

KEIL W2 TURBOKEIL X-SHAPE SDS PLUS DRILL BIT



QUICK	PART NO	SIZE (MM)	WORKING LENGTH (MM)	LENGTH (MM)	PACK QTY
-	4-060187	22mm	400	450	1
-	4-060188	24mm	400	450	1
-	4-060189	25mm	400	450	1
-	4-060190	28mm	400	450	1
-	4-060191	30mm	450	450	1

KEIL MS5 TURBOHEAD XPRO SDS PLUS DRILL BIT BULK 10 PACK



QUICK	PART NO	SIZE (MM)	WORKING LENGTH (MM)	LENGTH (MM)
-	4-060192	5	50	110
-	4-060193	5	100	160
-	4-060194	6	50	110
-	4-060195	6	100	160
-	4-060196	6	150	210
-	4-060197	8	100	160
-	4-060198	8	150	210
-	4-060199	10	100	160
-	4-060200	10	150	210
-	4-060201	12	100	160
-	4-060202	12	150	210
-	4-060203	12	200	260
-	4-060204	14	200	260

KEIL MS5 TURBOHEAD XPRO SDS PLUS MULTIPACK

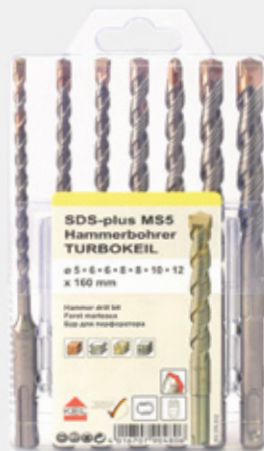

QUICK	PART NO	PACK QTY
-	4-060205	10
-	4-060206	10

SDS MAX DRILL BITS

KEIL W2 TURBOHEAD XPRO SDS MAX DRILL BIT



QUICK	PART NO	SIZE (MM)	WORKING LENGTH (MM)	LENGTH (MM)	PACK QTY
-	4-060207	12	200	340	1
-	4-060208	12	400	540	1
-	4-060209	12	550	690	1
-	4-060210	14	200	340	1
-	4-060211	14	400	540	1
-	4-060212	15	200	340	1
-	4-060213	15	400	540	1
-	4-060214	16	200	340	1
-	4-060215	16	400	540	1
-	4-060216	16	800	940	1
-	4-060217	18	200	340	1
-	4-060218	18	400	540	1
-	4-060219	18	800	940	1
-	4-060220	20	200	320	1
-	4-060221	20	400	520	1
-	4-060222	20	800	920	1
-	4-060223	20	1200	1320	1

KEIL SDS MAX MILLING CUTTER



QUICK	PART NO	SIZE (MM)	WORKING LENGTH (MM)	LENGTH (MM)	PACK QTY
-	4-060254	55	480	590	1
-	4-060255	55	880	990	1
-	4-060256	65	480	590	1
-	4-060257	65	880	990	1
-	4-060258	80	480	590	1
-	4-060259	80	880	990	1

KEIL W2 TURBOKEIL X-SHAPE SDS MAX DRILL BIT



QUICK	PART NO	SIZE (MM)	WORKING LENGTH (MM)	LENGTH (MM)	PACK QTY
-	4-060224	22	200	320	1
-	4-060225	22	400	520	1
-	4-060226	22	800	920	1
-	4-060227	22	1200	1320	1
-	4-060228	24	200	320	1
-	4-060229	24	400	520	1
-	4-060230	25	200	320	1
-	4-060231	25	400	520	1
-	4-060232	25	800	920	1
-	4-060233	25	1200	1320	1
-	4-060234	28	250	370	1
-	4-060235	28	450	570	1
-	4-060236	28	550	670	1
-	4-060237	30	250	370	1
-	4-060238	30	450	570	1
-	4-060239	32	250	370	1
-	4-060240	32	450	570	1
-	4-060241	32	800	920	1
-	4-060242	32	1200	1320	1
-	4-060243	35	250	370	1
-	4-060244	35	450	570	1
-	4-060245	38	250	370	1
-	4-060246	38	450	570	1
-	4-060247	40	250	370	1
-	4-060248	40	450	570	1
-	4-060249	40	800	920	1
-	4-060250	40	1200	1320	1
-	4-060251	45	450	570	1
-	4-060252	45	800	920	1
-	4-060253	50	450	570	1

SDS CORE DRILLS

KEIL BREAKTHROUGH CORE DRILL BIT HEAD W/RATIO THREAD



QUICK	PART NO	SIZE (MM)	PACK QTY
-	4-060260	35	1
-	4-060261	42	1
-	4-060262	45	1
-	4-060263	52	1
-	4-060264	55	1
-	4-060265	60	1
-	4-060266	65	1
-	4-060267	70	1
-	4-060268	80	1
-	4-060269	90	1
-	4-060270	100	1
-	4-060271	110	1
-	4-060272	125	1
-	4-060273	135	1
-	4-060274	150	1

KEIL RATIO THREAD BOLT



QUICK	PART NO	PACK QTY
-	4-060290	1

KEIL EXTENSION W/RATIO THREAD



QUICK	PART NO	LENGTH (MM)	PACK QTY
-	4-060288	300	1
-	4-060289	450	1

KEIL HOLLOW CORE DRILL BIT W/RATIO THREAD



QUICK	PART NO	SIZE (MM)	LENGTH (MM)	CUTTING DEPTH (MM)	PACK QTY
-	4-060275	40	100	75	1
-	4-060276	50	100	75	1
-	4-060277	60	100	75	1
-	4-060278	65	100	75	1
-	4-060279	80	100	75	1
-	4-060280	90	100	75	1
-	4-060281	100	100	75	1
-	4-060282	110	100	75	1
-	4-060283	125	100	75	1

KEIL CUTTING HELIX W/RATIO THREAD



QUICK	PART NO	SIZE (MM)	LENGTH (MM)	TO SUIT	PACK QTY
-	4-060284	32	80	32-45mm	1
-	4-060285	47	80	52-60mm	1
-	4-060286	63	80	65-70mm	1
-	4-060287	78	80	80-150mm	1

12X155MM KEIL HOLLOW CORE PILOT DRILL W/RATIO THREAD



QUICK	PART NO	SIZE (MM)	LENGTH (MM)	PACK QTY
-	4-060291	12	155	1

KEIL BREAKTHROUGH CORE PILOT DRILL W/RATIO THREAD



QUICK	PART NO	SIZE (MM)	LENGTH (MM)	PACK QTY
-	4-060292	16	124	1
-	4-060293	16	174	-

KEIL SDS PLUS RATIO THREAD ADAPTOR



QUICK	PART NO	LENGTH (MM)	PACK QTY
-	4-060294	110	1

KEIL SDS MAX RATIO THREAD ADAPTOR

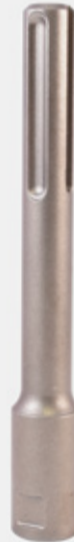

QUICK	PART NO	LENGTH (MM)	PACK QTY
-	4-060295	190	1
-	4-060296	400	1
-	4-060297	575	1
-	4-060298	975	1

KEIL RATIO THREAD GREASE 120G



QUICK	PART NO	LENGTH (MM)	PACK QTY
-	4-060294	110	1

SYSTEM 259 PRODUCT OVERVIEW

Adaptor



*Extension with
Threaded Bolt*



*Steel
Helix*



*Core Drill
Bits*



Drill Bits



EXAMPLES

Example 1



Example 2



Example 3



*Extendable to a
maximum 5 extensions*

SDS DUST EXTRACTION DRILL BITS

KEIL TURBOCLEAN SDS PLUS EXTRACTION DRILL BIT

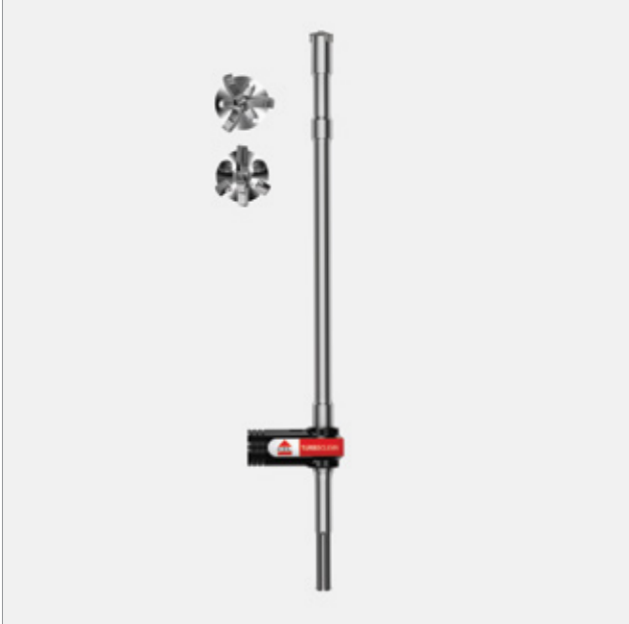

QUICK	PART NO	SIZE (MM)	WORKING LENGTH (MM)	LENGTH (MM)	PACK QTY
-	4-060311	8	150	270	1
-	4-060312	10	150	270	1
-	4-060313	12	200	320	1
-	4-060314	14	250	370	1
-	4-060315	16	250	370	1
-	4-060316	18	250	370	1
-	4-060317	20	250	370	1
-	4-060318	24	250	370	1

KEIL TURBOCLEAN SDS MAX EXTRACTION DRILL BIT



QUICK	PART NO	SIZE (MM)	WORKING LENGTH (MM)	LENGTH (MM)	PACK QTY
-	4-060300	14	400	600	1
-	4-060301	16	400	600	1
-	4-060302	18	400	600	1
-	4-060303	20	400	600	1
-	4-060304	22	400	600	1
-	4-060305	24	400	600	1
-	4-060306	25	400	600	1
-	4-060307	28	400	600	1
-	4-060308	30	400	600	1
-	4-060309	32	400	600	1
-	4-060310	35	400	600	1

SDS ADAPTORS

KEIL SDS PLUS SDS MAX ADAPTOR



QUICK	PART NO	PACK QTY
-	4-060319	1

KEIL SDS PLUS CHUCK ADAPTOR



QUICK	PART NO	PACK QTY
-	4-060320	1

SDS PLUS CHISELS

250MM KEIL SDS PLUS POINT CHISEL



QUICK	PART NO	LENGTH (MM)	PACK QTY
-	4-060321	250	1

KEIL SDS PLUS FLAT CHISEL



QUICK	PART NO	SIZE (MM)	LENGTH (MM)	PACK QTY
-	4-060322	20	140	1
-	4-060323	20	250	1

KEIL SDS PLUS SPADE CHISEL



QUICK	PART NO	SIZE (MM)	LENGTH (MM)	PACK QTY
-	4-060324	30	140	1
-	4-060325	40	250	1

22X250MM KEIL SDS PLUS HOLLOW CHISEL



QUICK	PART NO	SIZE (MM)	LENGTH (MM)	WEIGHT (KG)	PACK QTY
-	4-060326	22	250	0.3478	1

22X250MM KEIL SDS PLUS HOLLOW CHISEL W/GUIDES



QUICK	PART NO	SIZE (MM)	LENGTH (MM)	PACK QTY
-	4-060327	22	250	1

40X200MM KEIL SDS PLUS TILE CHISEL



QUICK	PART NO	SIZE (MM)	LENGTH (MM)	PACK QTY
-	4-060328	40	200	1

250MM KEIL SDS PLUS SELF SHARPENING POINT CHISEL



QUICK	PART NO	LENGTH (MM)	PACK QTY
-	4-060329	250	1

KEIL SDS PLUS SELF SHARPENING FLAT CHISEL

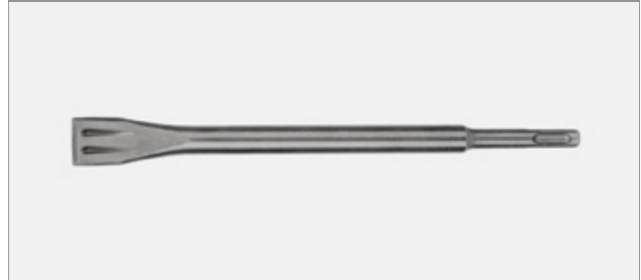

QUICK	PART NO	SIZE (MM)	LENGTH (MM)	PACK QTY
-	4-060330	20	250	1
-	4-060331	40	250	1
-	4-060332	60	250	1

SDS MAX CHISELS

KEIL SDS MAX POINT CHISEL



QUICK	PART NO	LENGTH (MM)	PACK QTY
-	4-060333	280	1
-	4-060334	400	1
-	4-060335	600	1

KEIL SDS MAX FLAT CHISEL



QUICK	PART NO	SIZE (MM)	LENGTH (MM)	PACK QTY
-	4-060336	25	280	1
-	4-060337	25	400	1
-	4-060338	25	600	1

KEIL SDS MAX SPADE CHISEL



QUICK	PART NO	SIZE (MM)	LENGTH (MM)	PACK QTY
-	4-060339	80	300	1
-	4-060340	50	400	1

26X300MM KEIL SDS MAX HOLLOW CHISEL



QUICK	PART NO	SIZE (MM)	LENGTH (MM)	PACK QTY
-	4-060341	26	300	1

35X380MM KEIL SDS MAX HOLLOW CHISEL W/GUIDES



QUICK	PART NO	SIZE (MM)	LENGTH (MM)	PACK QTY
-	4-060342	35	380	1

50X300MM KEIL SDS MAX TILE CHISEL



QUICK	PART NO	SIZE (MM)	LENGTH (MM)	PACK QTY
-	4-060343	50	300	1

400MM KEIL SDS MAX SELF SHARPENING POINT CHISEL



QUICK	PART NO	LENGTH (MM)	PACK QTY
-	4-060344	400	1

KEIL SDS PLUS SELF SHARPENING FLAT CHISEL



QUICK	PART NO	SIZE (MM)	LENGTH (MM)	PACK QTY
-	4-060345	25	400	1
-	4-060346	80	400	1

MASONRY DRILL BITS

KEIL MS5 TURBOKEIL MASONRY DRILL BIT

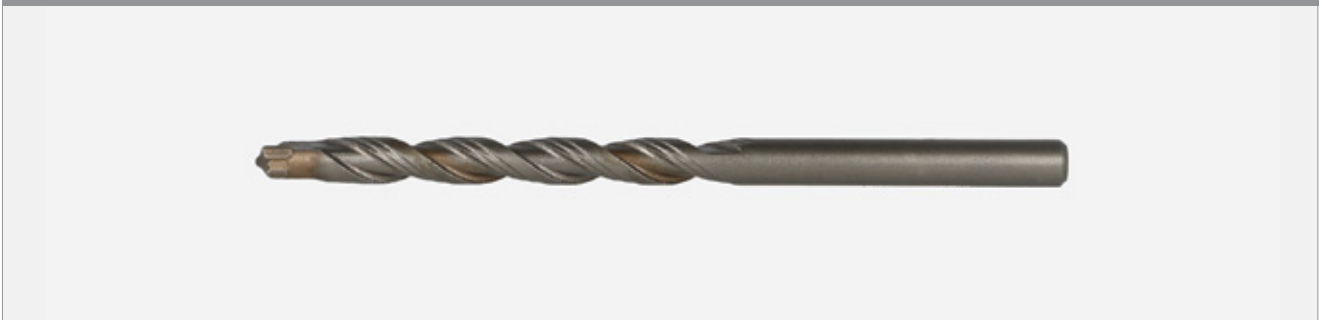

QUICK	PART NO	SIZE (MM)	WORKING LENGTH (MM)	LENGTH (MM)	PACK QTY
-	4-060387	3	40	70	1
-	4-060388	4	40	75	1
-	4-060389	5	50	85	1
-	4-060390	6	60	100	1
-	4-060391	7	60	100	1
-	4-060392	8	75	120	1
-	4-060393	9	75	120	1
-	4-060394	10	75	120	1
-	4-060395	12	100	150	1
-	4-060396	14	100	150	1
-	4-060397	16	100	150	1

KEIL MS5 TURBOKEIL MASONRY DRILL BIT



QUICK	PART NO	SIZE (MM)	WORKING LENGTH (MM)	LENGTH (MM)	PACK QTY
-	4-060398	5	50	85	20
-	4-060399	6	60	100	20
-	4-060400	8	75	120	20
-	4-060401	10	75	120	20
-	4-060402	12	100	160	10
-	4-060403	14	100	160	10

UNIVERSAL & SPECIAL DRILL BITS

KEIL MS5 TURBOKEIL MASONRY DRILL BIT



QUICK	PART NO	SIZE (MM)	WORKING LENGTH (MM)	LENGTH (MM)	PACK QTY
-	4-060347	5	50	110	1
-	4-060348	6	50	110	1
-	4-060349	6	100	160	1
-	4-060350	8	50	110	1
-	4-060351	8	100	160	1
-	4-060352	8	150	210	1
-	4-060353	10	100	160	1
-	4-060354	10	200	260	1
-	4-060355	12	100	165	1
-	4-060356	12	200	260	1
-	4-060357	14	200	265	1

KEIL GOLDCRAFT UNIVERSAL DRILL BIT



QUICK	PART NO	SIZE (MM)	WORKING LENGTH (MM)	LENGTH (MM)	PACK QTY
-	4-060358	3	40	70	20
-	4-060359	4	40	75	20
-	4-060360	5	50	85	20
-	4-060361	5	110	160	10
-	4-060362	5.5	50	85	20
-	4-060363	6	60	100	20
-	4-060364	6	110	150	10
-	4-060365	6	200	250	10
-	4-060366	6.5	60	100	20
-	4-060367	6.5	110	150	10
-	4-060368	6.5	200	250	10
-	4-060369	7	60	100	20
-	4-060370	7	200	250	10
-	4-060371	8	80	120	20
-	4-060372	8	135	200	10
-	4-060373	9	80	120	20
-	4-060374	10	80	120	20
-	4-060375	10	135	200	10
-	4-060376	12	90	150	10
-	4-060377	12	135	200	10
-	4-060378	14	90	150	10
-	4-060379	16	90	150	10

KEIL GOLDCRAFT UNIVERSAL DRILL BIT MULTIPACK 7/PK



QUICK	PART NO	PACK QTY
-	4-060380	10

KEIL HARDTEC HARD STONE DRILL BIT



QUICK	PART NO	SIZE (MM)	WORKING LENGTH (MM)	LENGTH (MM)	PACK QTY
-	4-060381	4	40	75	20
-	4-060382	5	50	85	20
-	4-060383	6	60	100	20
-	4-060384	8	75	120	20
-	4-060385	10	75	120	20

KEIL HARDTEC HARD STONE DRILL BIT MULTIPACK 5/PK



QUICK	PART NO	PACK QTY
-	4-060386	10

KEIL SPEAR DRILL BIT



QUICK	PART NO	SIZE (MM)	LENGTH (MM)	PACK QTY
-	4-060428	3	58	20
-	4-060429	4	58	20
-	4-060430	5	58	20
-	4-060431	5.5	58	20
-	4-060432	6	58	20
-	4-060433	7	78	20
-	4-060434	8	78	20
-	4-060435	10	98	20
-	4-060436	12	98	20

KEIL SPEAR DRILL BIT - 1/4 HEX

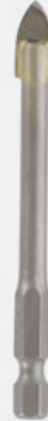

QUICK	PART NO	SIZE (MM)	LENGTH (MM)	PACK QTY
-	4-060437	3	75	20
-	4-060438	4	75	20
-	4-060439	5	75	20
-	4-060440	6	75	10
-	4-060441	8	85	20
-	4-060442	10	85	20

DIAMOND DRILL BITS

KEIL KERAMIK DIAMOND TILE DRILL BIT



QUICK	PART NO	SIZE (MM)	LENGTH (MM)	PACK QTY
-	4-060404	5	67	1
-	4-060405	6	67	1
-	4-060406	8	80	1
-	4-060407	10	80	1
-	4-060408	12	80	1
-	4-060409	15	80	1
-	4-060410	20	70	1
-	4-060411	25	70	1
-	4-060412	30	70	1
-	4-060413	35	70	1
-	4-060414	68	70	1

KEIL KERAMIK DIAMOND TILE DRILL BIT - M14



QUICK	PART NO	SIZE (MM)	LENGTH (MM)	PACK QTY
-	4-060415	5	62	1
-	4-060416	6	62	1
-	4-060417	8	62	1
-	4-060418	10	62	1
-	4-060419	12	62	1
-	4-060420	15	62	1
-	4-060421	20	60	1
-	4-060422	25	60	1
-	4-060423	30	60	1
-	4-060424	35	60	1

KEIL TILE DRILL GUIDE 6-83MM



QUICK	PART NO	SIZE (MM)	PACK QTY
-	4-060427	6-83	1

KEIL TILE DRILL SPRAY BOTTLE



QUICK	PART NO	PACK QTY
-	4-060425	1

KEIL TILE DRILL GUIDE 4-13MM



QUICK	PART NO	SIZE (MM)	PACK QTY
-	4-060426	4-13	1



Melbourne

15 Corporate Place
Broadmeadows
VIC 3047

 Sales and Support
03 8301 9999

Sydney

Unit 14, Cumberland Green
Estate 2-8 South Street
Rydalmere, NSW 2116

 Sales and Support
02 9737 0099

Launceston

3/34 Innocent Street
Kings Meadows
TAS 7249

 Sales and Support
03 6343 6484

Hobart

273d Kennedy Drive
Cambridge
TAS 7170

 Sales and Support
03 6272 1190

 sales@drillcut.com.au

 1800 374 552

 drillcut.au

